

Improvements in Monitor Loudspeaker Systems*

DAVID SMITH, D. B. KEELE, JR., AND JOHN EARGLE

James B. Lansing Sound, Inc., Northridge, CA 91329, USA

As the recording industry enjoys the benefits of both digital and advanced analog recording technology, attention is appropriately focused on the use of compression driver and horn designs which are some 25–30 years old. Evolutionary improvements in woofers, compression drivers, and dividing networks combined with new constant-coverage horn designs have resulted in a frequency response more consistently uniform at all coverage angles (yielding flat power response) along with lowered distortion and increased acoustic power output at the frequency extremes.

0 INTRODUCTION

High-quality studio monitor loudspeaker systems have evolved out of the theater traditions of the 1930s and 1940s. These systems, whether of two-, three-, or four-way design, invariably make use of compression drivers in their mid- and high-frequency sections for greater reliability at elevated output levels. These design traditions have been eschewed by the “audiophile” segment of the consumer market, who have in general preferred the relative smoothness and low distortion (at moderate levels) of cone and dome direct radiating systems. As audiophile record productions take on a more conspicuous profile, and as digital recording technology promises higher orders of performance in the studio, we once again examine and attempt to reconcile the apparent differences between that which the dedicated audiophile feels to be a state-of-the-art approach to loudspeaker design—and that which experienced recording engineers require for their specific needs.

Among the chief performance parameters we have identified are uniform polar response and directivity, smooth power response, and low distortion. A secondary requirement is for accurate stereophonic imaging at close-in listening positions in the studio control room. A new family of constant-directivity horns has formed the basis of a new approach to monitor design, and we will now describe two monitor loudspeakers embodying them.

* Presented at the 69th Convention of the Audio Engineering Society, Los Angeles, 1981 May 12–15; revised 1983 March 29.

1 THE CONSTANT-DIRECTIVITY HORN

Horns used in previous monitors were of the radial type or, alternatively, straight exponential with a horizontally divergent acoustic lens. Either type offered wide but uncontrolled horizontal response at the expense of narrow vertical response at the highest frequencies and constantly rising directivity with frequency. Recent developments in horns (Keele [1], Henricksen and Ureda [2]) yield very uniform vertical and horizontal coverage patterns which change little with frequency. These horns provide surprisingly constant angular coverage along with very stable directivity over their operating range. This alone cures the worst complaints about previous horns and makes systems using such horns truly a new generation of monitors.

Optimal horn parameters for monitor use are as follows.

- 1) Constant coverage angle with consistent polar patterns, both horizontally and vertically controlled over the total operating range (1000 Hz to 16 000 Hz).
- 2) Coverage angles wide enough to mate at crossover with a cone woofer (90°–100° square or a directivity index [DI] of about 8 dB).
- 3) Faster flare than previously used, for lower second-harmonic distortion.
- 4) Shorter length to place woofer and horn in the same acoustic plane.

The first version of a constant-directivity horn (Keele [1]) was basically a much improved radial horn with end flaring to combat midrange narrowing and maintenance of high-frequency beamwidth by elimination of the typical radial horn neck. A second version de-

scribed by Henricksen and Ureda [2] brought vertical angle control down to a lower frequency by flipping conventional horns 90° onto their sides, which allowed a much larger vertical height without the width growing too excessively. Flat surface flares with hard transitions were used for manufacturing ease. A third version by Keele combines the better points of the previous two with several improvements: the vertical flare is fed by a diffraction slot, which can be made narrow enough to feed a wide horizontal angle up to any desired frequency. The primary and end flares have rounded transitions as on the previous Keele horn, but rather than being arbitrarily rounded, the side contours are defined by a three-term mathematical expression:

$$y = a + bx + cx^n$$

where b determines the initial wall angle and the cx^n term determines the amount of mouth flaring (see Fig. 1). The performance of such a horn is compared to that of a prior art radial horn and of an exponential horn with acoustic lens in Figs. 2–4. Its –6-dB coverage angles and directivity index are quite consistent.

2 THE COMPRESSION DRIVER AND ITS EQUALIZATION

Previous horns were judged on their ability to generate flat response on axis with typical compression drivers. This persisted, even though compression drivers were known to fall off in power response above the midband. A typical driver whose power response rolls off at 6

dB per octave above 3 kHz (Newman [3]) would require a horn with a reciprocal increase in directivity index. The compression driver would then be acoustically equalized, but only on axis, as shown in Fig. 5.

When this compression driver is loaded by a constant-directivity horn, the axial response follows the power response of the driver, as shown by Fig. 6. The very high midband efficiency given by horn loading allows passive equalization for both flat axial and, at the same time, flat power response. A typical network configuration is shown in Fig. 7. The midband sensitivity is reduced by the L-pad and dividing network. The highs are shunted across this attenuation by a second-order bandpass filter tuned to the highest operating frequency. Independent control of the midrange and high end are an added benefit.

When the high end of the horn–driver combination is properly equalized [Fig. 8(a)], we can return the compression driver to the constant impedance plane wave tube and verify that its power response is now flat [Fig. 8(b)].

3 THE WOOFER

Woofers for monitor use have been slowly but constantly evolving over the past 20 years. The ideal woofer must have:

- 1) A smooth response curve with the required midband sensitivity
- 2) Controlled directional characteristics
- 3) High output at low distortion levels

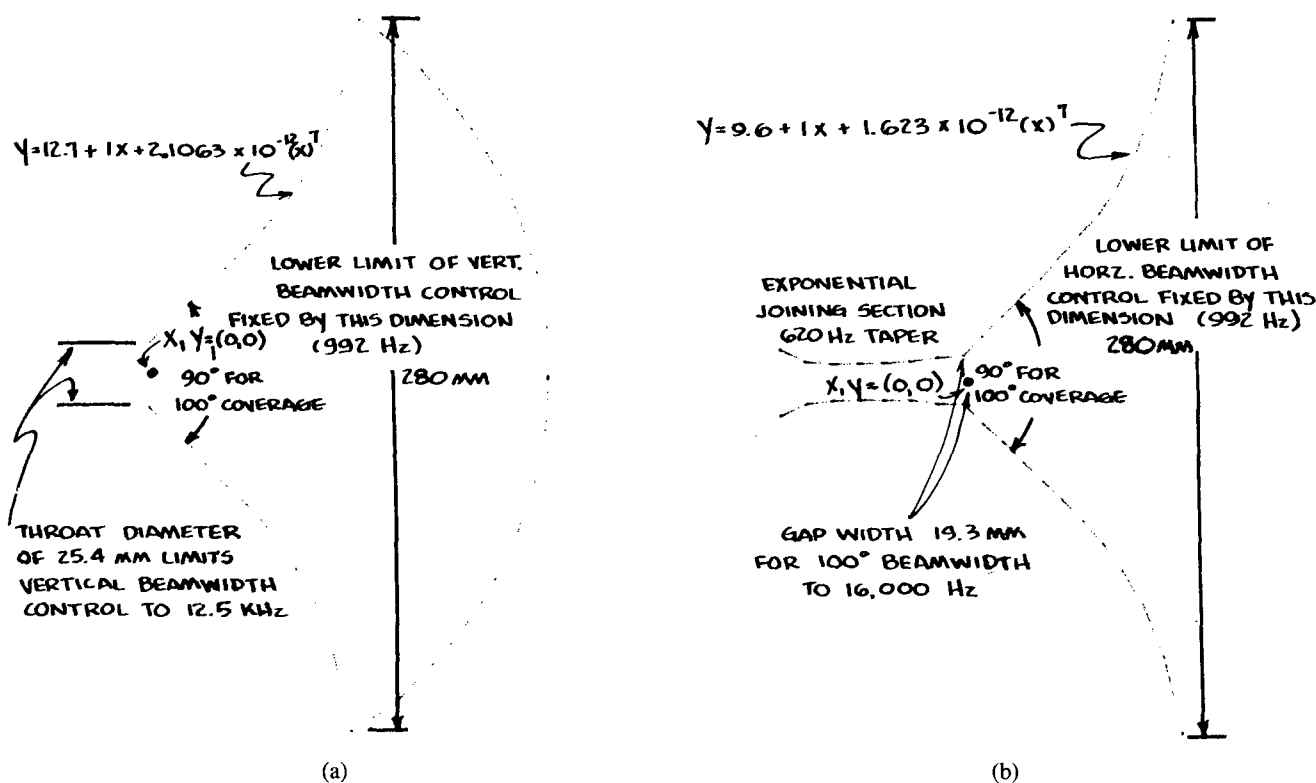

Fig. 1. Keele constant-coverage biradial horn (JBL 2344), computer-generated plot. All dimensions in mm. (a) Vertical cross section. (b) Horizontal cross section.

4) Freedom from dynamic offset problems

It is commonly thought that 380-mm (15-in) woofers cannot be used up to 1000 Hz due to poor frequency response and ragged polar characteristics. Fortunately this need not always be the case. If the cone stock is well chosen and properly terminated at its surround compliance, then its response will be smooth, both on and off axis, to the 1-kHz region. Fig. 9 shows the beamwidth and the directivity index of a 380-mm woofer mounted in an enclosure of typical size (0.17 m³, 6 ft³). The directivity rises smoothly, until at 1000 Hz it becomes an even match for a 100° by 100° horn.

The high price of Alnico V magnets has forced most manufacturers to use ferrite magnet structures, even though these were previously regarded as higher in distortion. Improved geometry and the use of flux modulation canceling rings has reduced their distortion levels to less than the equivalent Alnico structure (Gander [4] and Gilliom [5]). An added benefit is the elimination of the Alnico structure's tendency to demagnetize itself under high-power low-frequency pulses.

Woofer dynamic offset is a problem long known about but seldom discussed or treated. With high input power

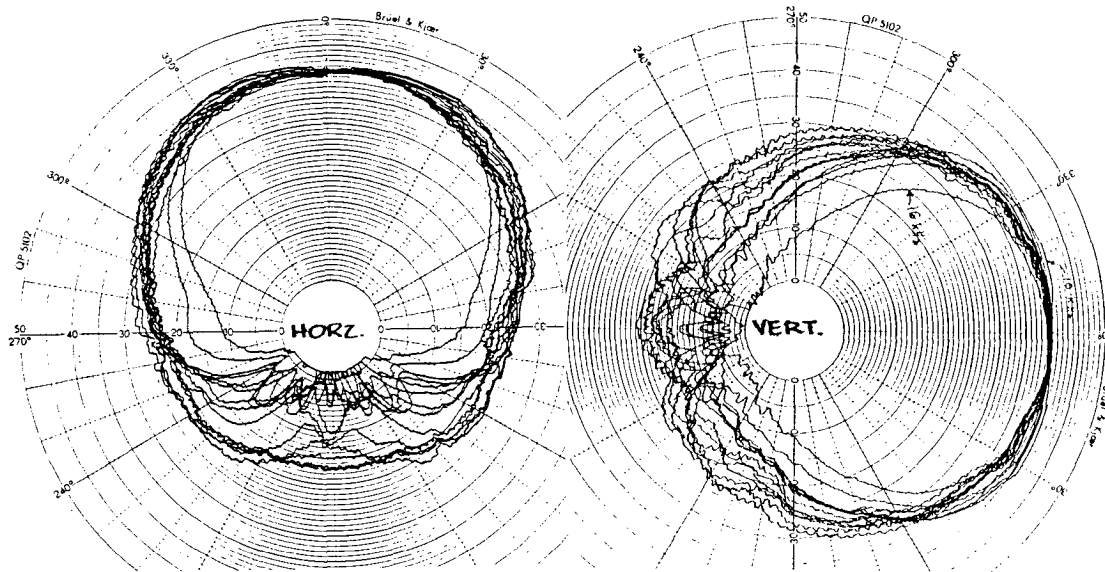

(a)

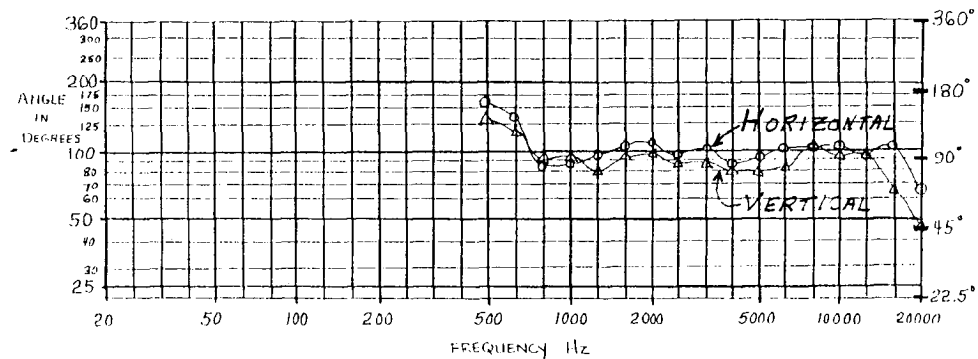

(b)

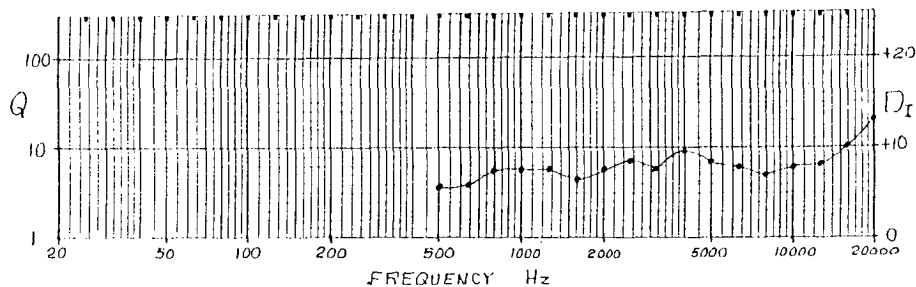

(c)

Fig. 2. Polar response, beamwidth and directivity of constant-coverage horn shown in Fig. 1. (a) Composite plot of one-third-octave bandwidth polar curves at all one-third-octave center frequencies from 800–1600 Hz (1 dB per minor division). (b) Beamwidth versus frequency. (c) Directivity versus frequency.

at low frequencies, many woofers tend to shift their mean displacement forward or backward until the coil is nearly out of the gap. This is most likely to happen just above each low-frequency impedance peak of a system. The result is a high level of second-harmonic distortion and subjectively a bass character that loses its tightness at high acoustic output levels [4]. The cure for offset, as shown by Wiik [6], is a restoring spring force that increases in stiffness at high displacement in an amount that counterbalances the reduced B field at the extremes of voice coil travel. Such a non-linear spider will in fact reduce distortion and eliminate the tendency to offset.

4 DIVIDING NETWORK CONSIDERATIONS

The main goal of good network design is to produce the flattest response over the widest range of listening angles. The three-dimensional position dependence of the frequency response of a loudspeaker system, as controlled by the network, is generally overlooked. Response at off angles and total power response are of major concern. Each trial network with good axial curves must be measured at many angles, up and down, left and right. Those that pass this phase of testing will of course be further tested for power response and directivity characteristics, and will then be taken to the

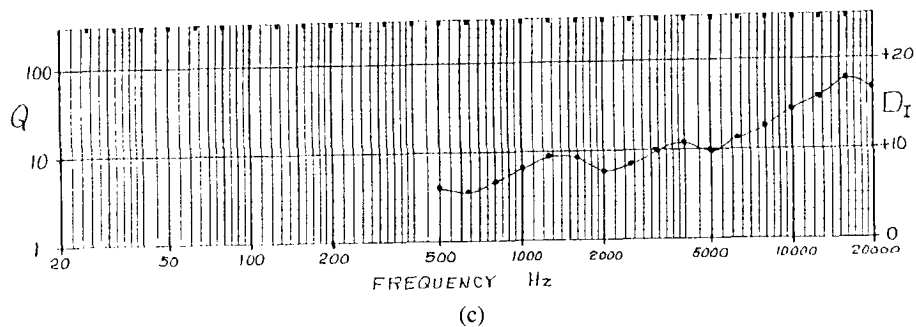
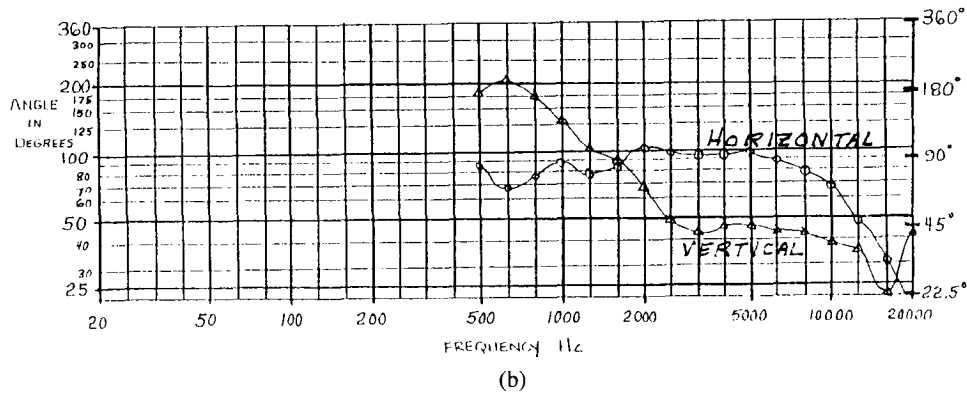
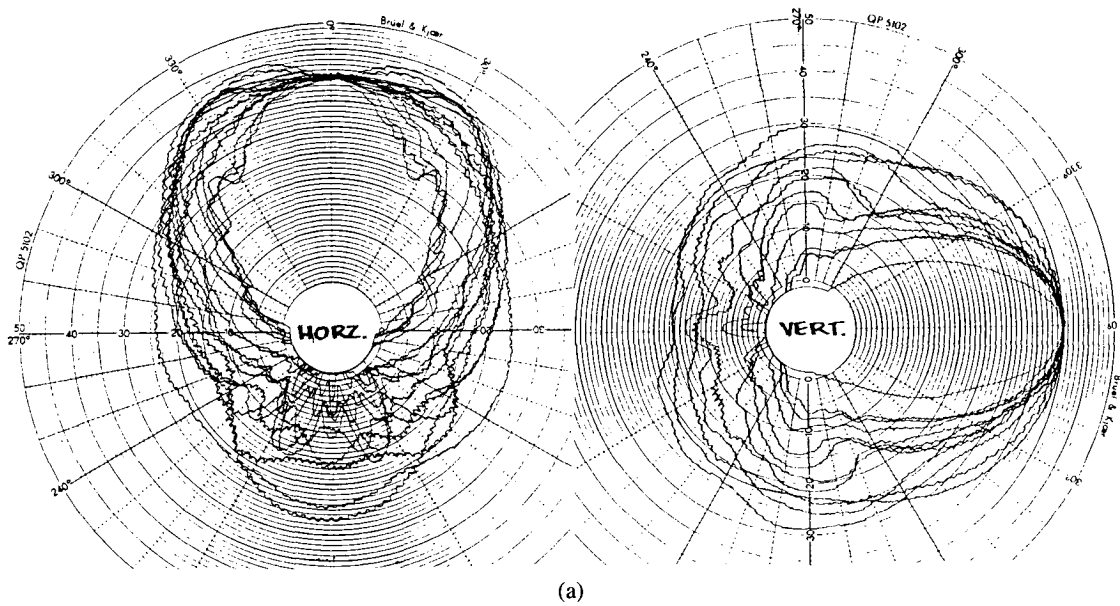

Fig. 3. Polar response, beamwidth and directivity index of radial horn (Altec 511B). (a) Polar composites 800–16 000 Hz. (b) Beamwidth versus frequency. (c) Directivity versus frequency.

studio for measurement and exhaustive listening tests.

Crossover nulls that appear at off-axis angles are an inevitable consequence of the finite driver spacing. In noncoaxial designs the spacing is usually in the vertical plane, and it causes the woofer-to-listener and tweeter-to-listener distances to vary as the system axis is tilted. Linkwitz [7] shows that the angle between nulls is roughly defined by the wavelength of sound at the crossover frequency and the vertical spacing (see Fig. 10). It is given by

$$\alpha = \arcsin\left(\frac{\lambda_c}{2d_1}\right)$$

where

α = half-angle between nulls

λ_c = wavelength at crossover frequency

d_1 = center-to-center spacing (vertical array assumed)

For example, a 1000-Hz crossover frequency and a spacing of 0.4 m yields

$$d_1 = 0.4 \text{ m (16 in)}$$

$$\lambda_c = 0.34 \text{ m (13.5 in)}$$

$$\alpha = 25^\circ \text{ or } 2\alpha = 50^\circ \text{ (arc between nulls)}$$

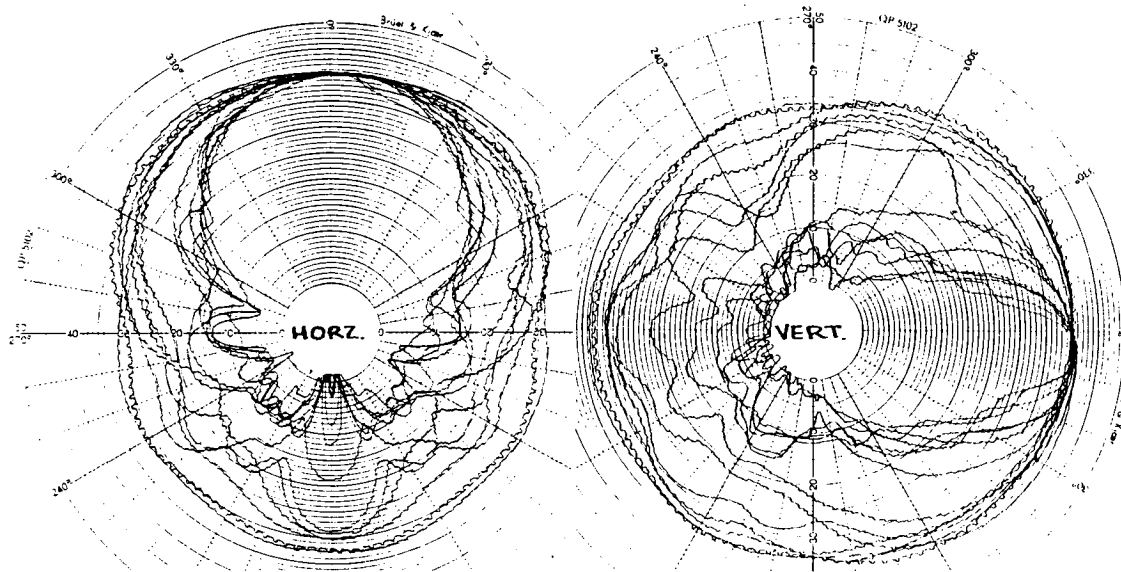

(a)

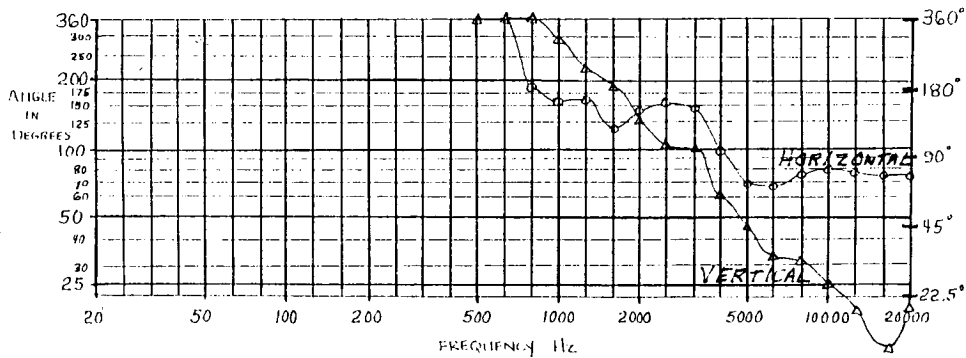

(b)

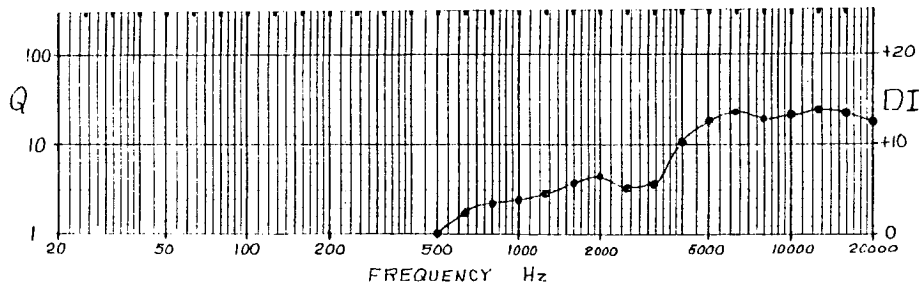

(c)

Fig. 4. Polar response, beamwidth and directivity index of straight exponential horn and divergent lens (JBL 2307/2308). (a) Polar composites 800–16 000 Hz. (b) Beamwidth versus frequency. (c) Directivity versus frequency.

The arc between nulls can be made more useful if it is tilted upward. That is, floor-standing systems should be optimized for response at angles on axis and above. If the system is to be used above ear level, then inverting it will once again yield the greatest latitude of listener positioning.

It is also important that crossover nulls in the off-axis frequency response be as narrow and unobtrusive as possible. This is usually assured by higher order network transitions with minimal overlap.

5 PERFORMANCE

A two-way monitor using the new horn and a 380-mm (15-in)-nominal-diameter woofer was designed which meets all the previously mentioned criteria (model 4430). Its performance in a variety of tests has been measured in comparison to previous designs of this and other companies.

The measurements most vital in revealing the performance of this type of monitor are the beamwidth and directivity curves. Use of a computer-operated measurement system reduced the tediousness of these measurements and calculations (Keele [8]).

Figs. 11–13 show comparisons of the beamwidth and directivity of the 4430 (Fig. 11) to two previous monitors. Our two-way 4331 model (Fig. 12) had wide horizontal coverage but poor vertical coverage and constantly rising directivity. The DI versus frequency of the coaxial design (Fig. 13) appears smooth, yet the directivity index of the horn at higher frequencies is greater than that of the woofer by 4 dB, revealing a poor horn–woofer match. It is doubtful that a wide-angle horn with good midrange control could be built into the available space of a typical coaxial design. Beamwidth versus frequency of this horn shows an interesting but undesirable trait, in that coverage angles vary in a complementary fashion, which maintains

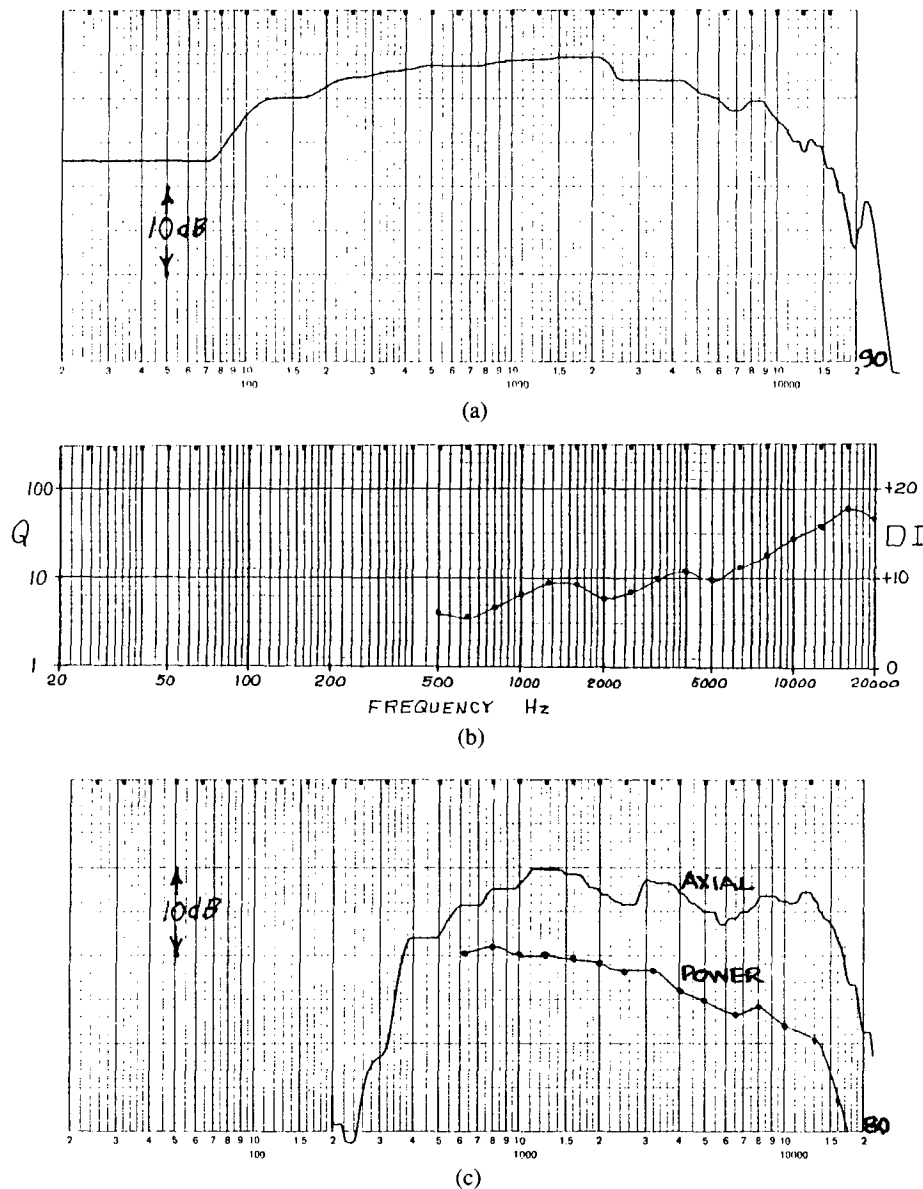

Fig. 5. Acoustic equalization of compression driver by beaming horn. (a) Power response of compression driver (terminated tube response). (b) Directivity index of horn. (c) Response of horn and driver. Power curve = axial curve – DI curve. Axial curve is flat, but power curve rolls off.

consistent DI but does little to help off-axis response.

Figs. 14–16 show the normalized off-axis frequency response curves of the three systems. These curves represent those that would result from equalizing the axial response flat.

Power compression versus level is plotted in Fig. 17. As the power levels were increased, the chart recorder gain was decreased a like amount. The degree to which the curves coincide shows the system's freedom from the effects of compression. These curves were

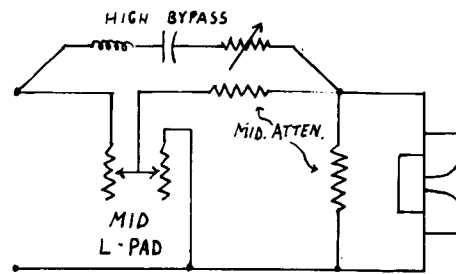
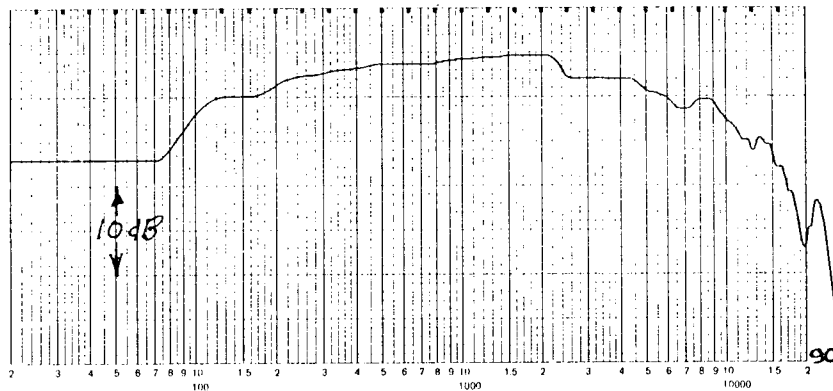
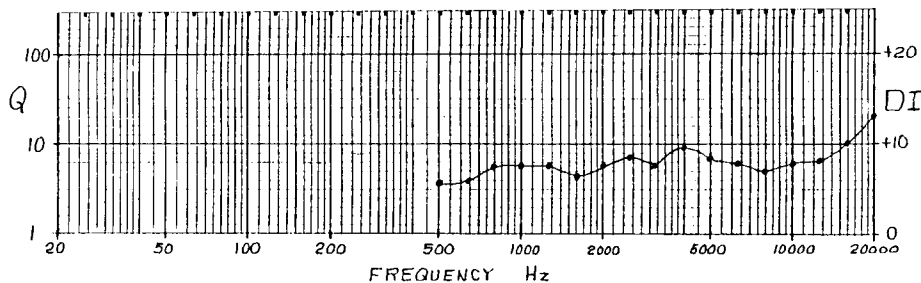

Fig. 7. High-end equalization network.



(a)



(b)

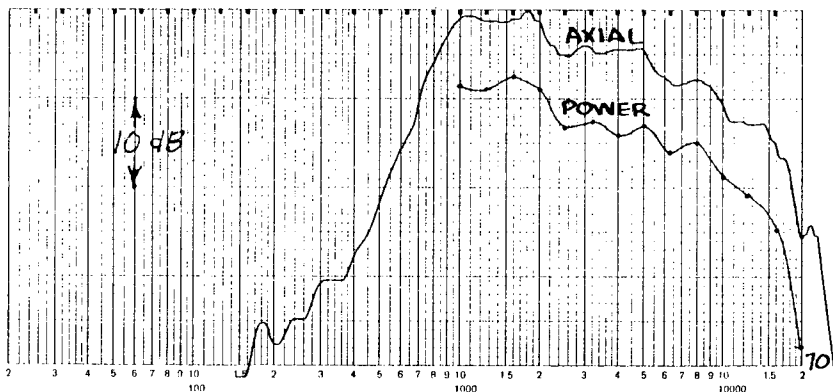

(c)

Fig. 6. Axial and power response of constant-coverage horn. (a) Power response of compression driver (terminated tube response). (b) Directivity index of horn. (c) Response of horn and driver. Power curve = axial curve - DI curve. Power and axial curves run parallel.

run using a narrow-band tracking filter. The purpose of this tracking filter is to remove distortion components which would lessen the apparent compression as energy is transferred from the fundamental to harmonics. Conventional distortion curves are also shown in Fig. 18.

The group delay characteristics of the 4430, earlier 4331, and a popular constant group delay monitor are all plotted in Fig. 19 versus the Blauert and Laws criteria for minimum audible time delay discrepancies [9]. Here the constant group delay monitor excels, although all three easily fall well below the criteria.

For uses where even greater low-frequency output capability with an attendant reduction in distortion is

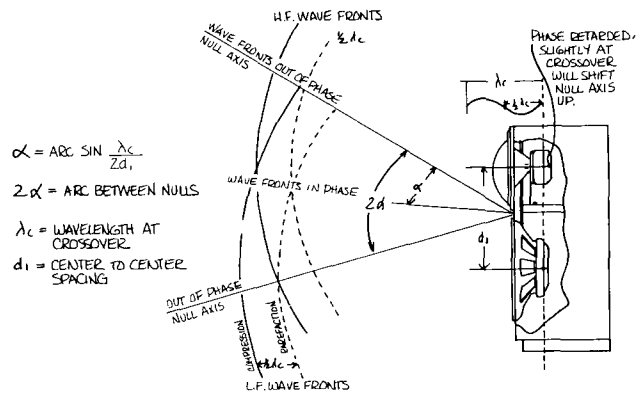
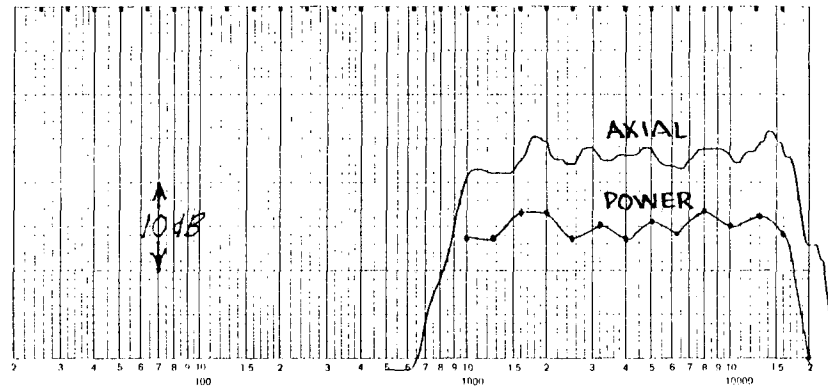
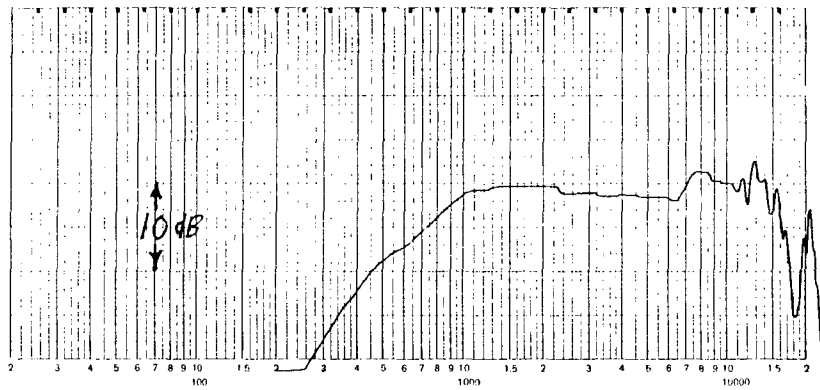

Fig. 10. Geometric causes of vertical off-axis response nulls.



(a)



(b)

Fig. 8. Equalized horn response and resultant driver power response. (a) Compression driver and horn electrically equalized. (b) Equalized compression driver on terminated tube. Both axial and power responses are flat.

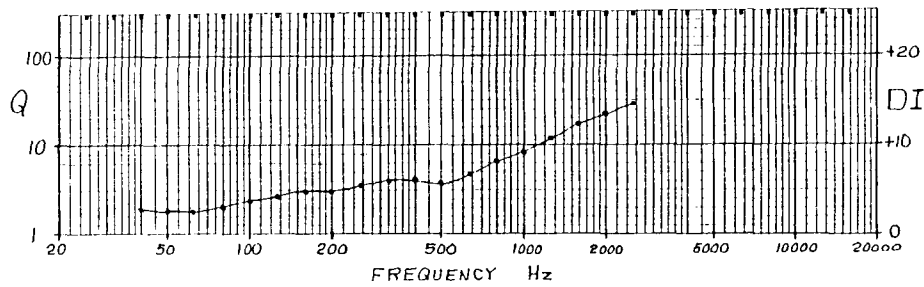

Fig. 9. Directivity index of 380-mm woofer.

required, a double woofer system has been designed (model 4435). Directional characteristics have been left intact by bringing the second woofer in below 100 Hz only. The maximum output before thermal or excursion limiting has been raised by 4 dB and extended

on the low end by half an octave. This is shown in Fig. 20. Note that this is not a response curve but instead is a curve of maximum reverberant field sound pressure level generated at the excursion limit or long-term power limit of the two systems in typical monitoring condi-

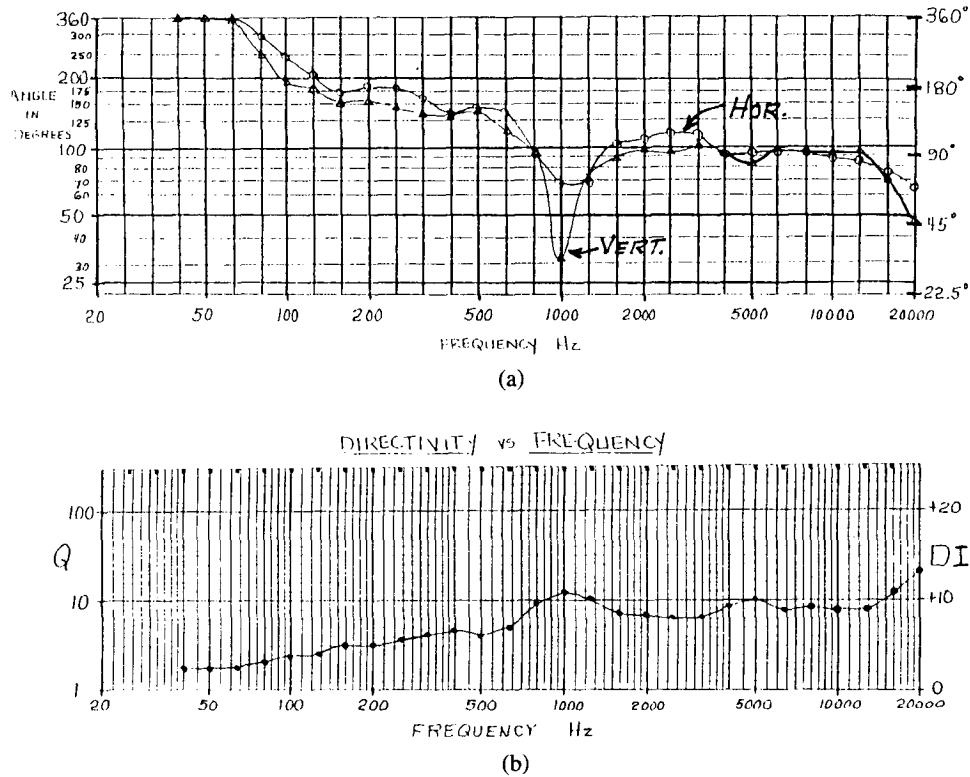

Fig. 11. Beamwidth and directivity index of constant-energy response monitor (JBL 4430). (a) Beamwidth. (b) Directivity index.

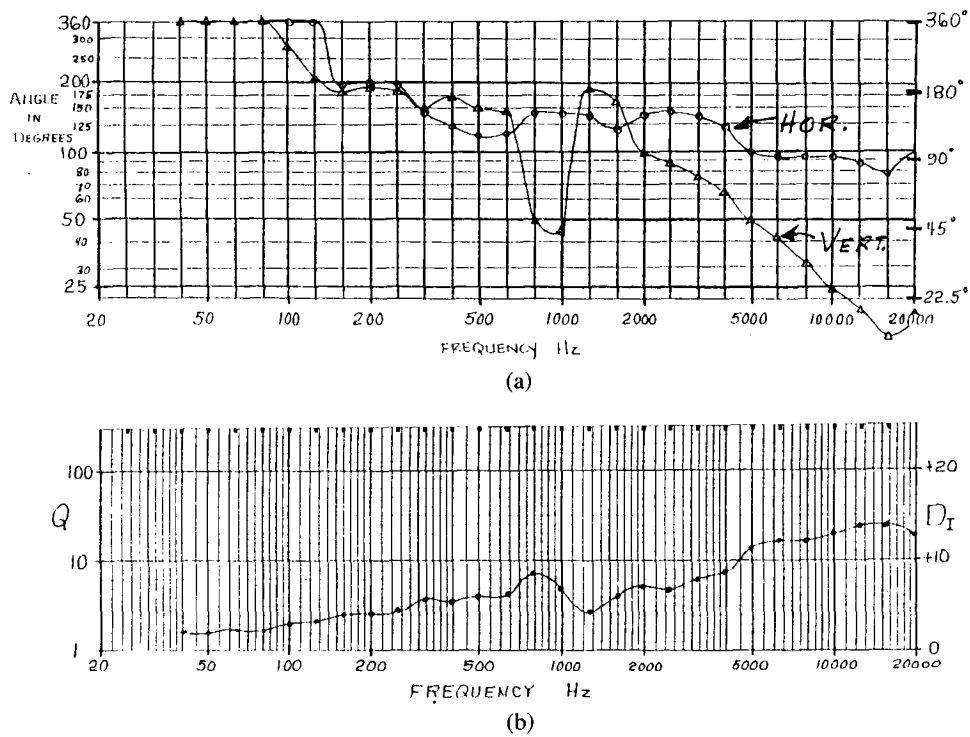
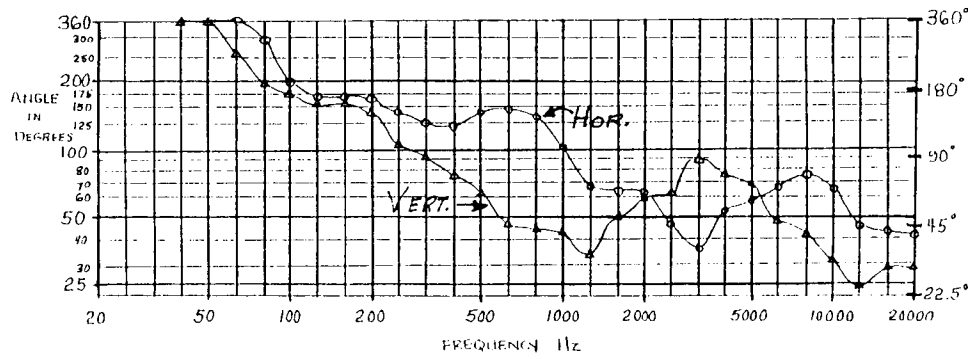
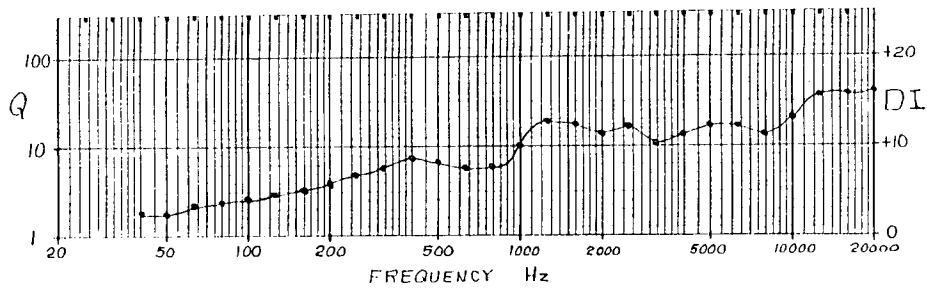

Fig. 12. Beamwidth and directivity index of two-way monitor (JBL 4331) using a 380 mm woofer and horn-lens assembly. (a) Beamwidth. (b) Directivity.



(a)



(b)

Fig. 13. Beamwidth and directivity index of a popular coaxial-style monitor (UREI 813). (a) Beamwidth. (b) Directivity index.

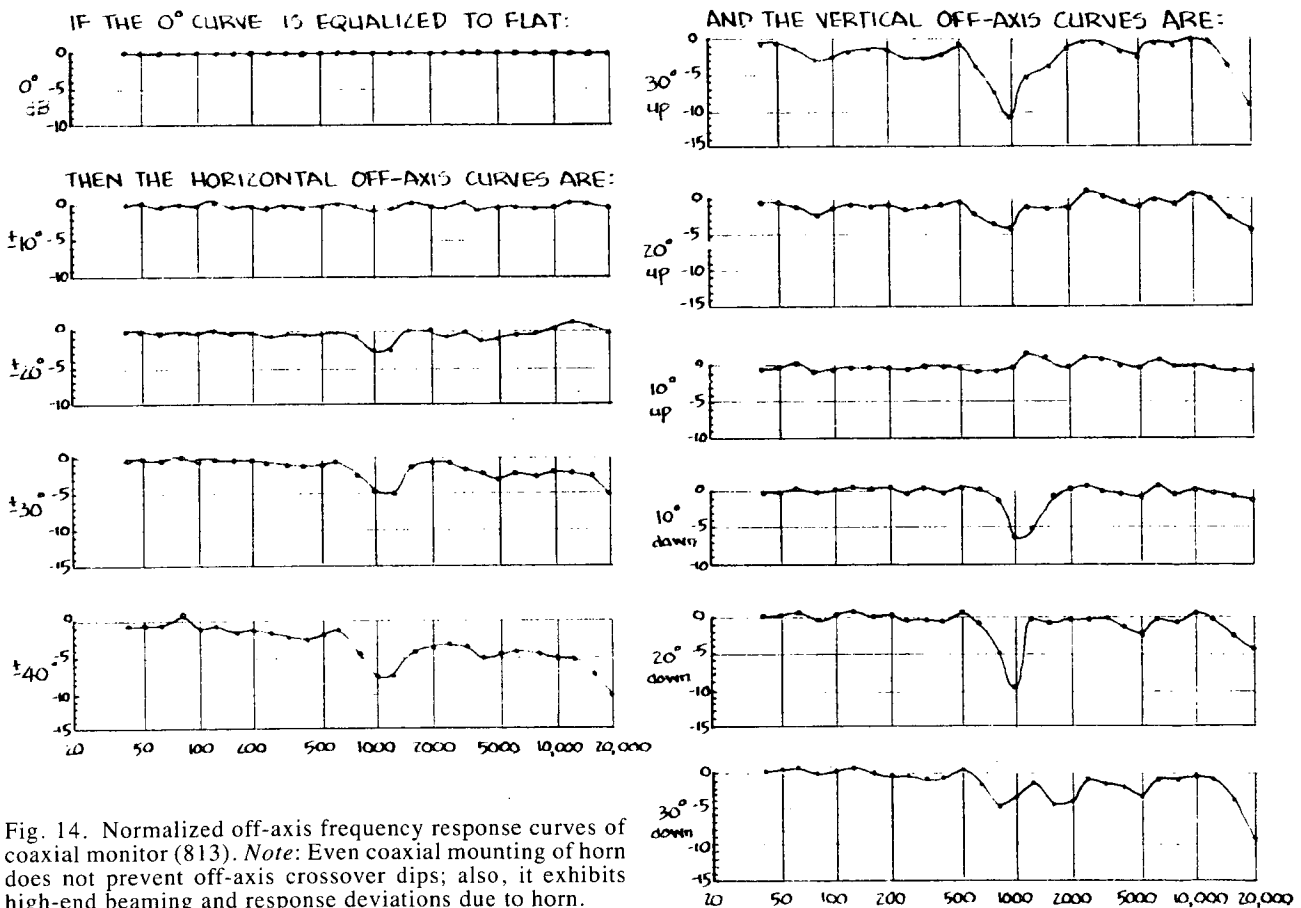
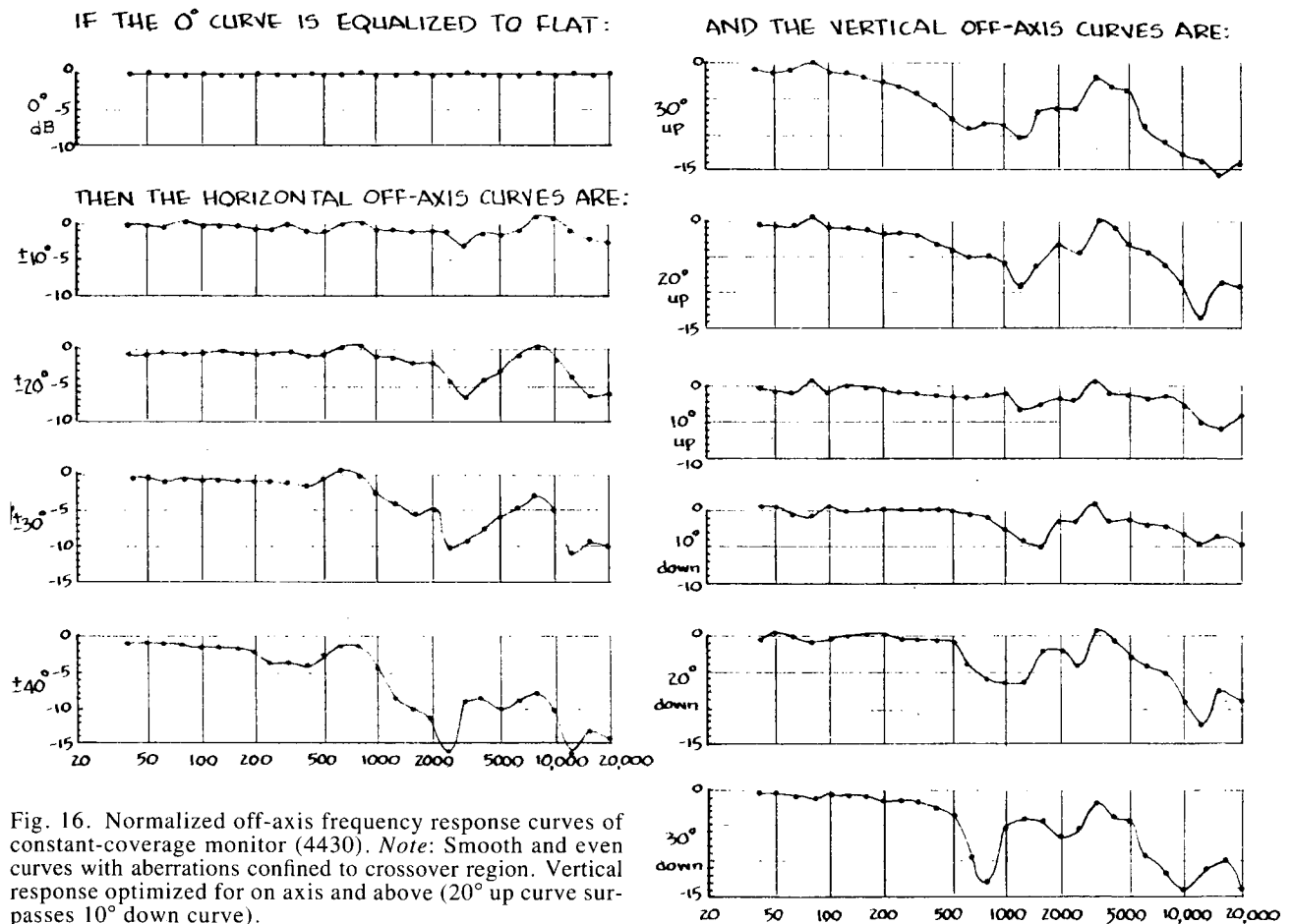
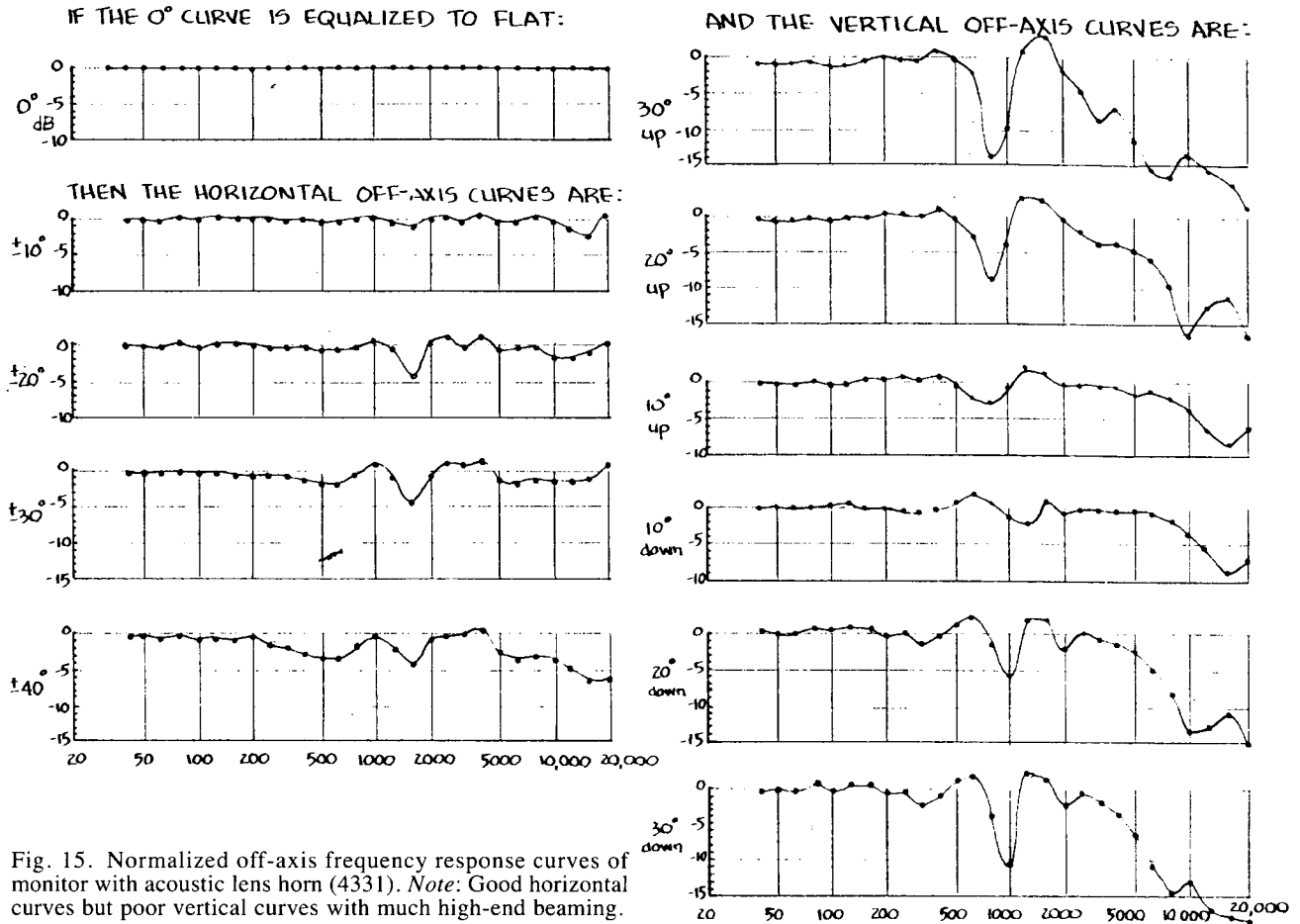

Fig. 14. Normalized off-axis frequency response curves of coaxial monitor (813). Note: Even coaxial mounting of horn does not prevent off-axis crossover dips; also, it exhibits high-end beaming and response deviations due to horn.



tions. In the very low-frequency range of 20–30 Hz a stereo pair of the dual woofer systems can generate some 115–120 dB sound pressure level under these conditions.

Both low-frequency drivers in the double system are identical to the driver in the single system except for lightened cones, which yield a 3-dB increase in midband sensitivity.

6 RAMIFICATIONS OF THE NEW DESIGN APPROACH

6.1 The Room Curve Will Be Flatter; Equalization Will Be More Accurate

Studio monitors are generally equalized as a matter of course. Control rooms are rarely as smooth at low frequencies as may be desired, and mounting conditions

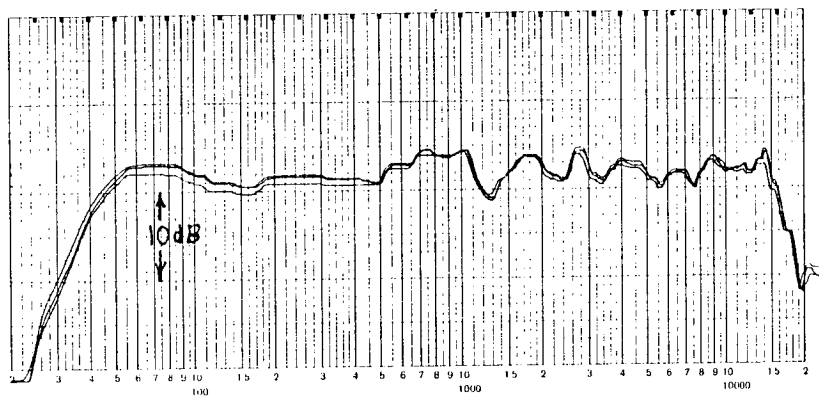
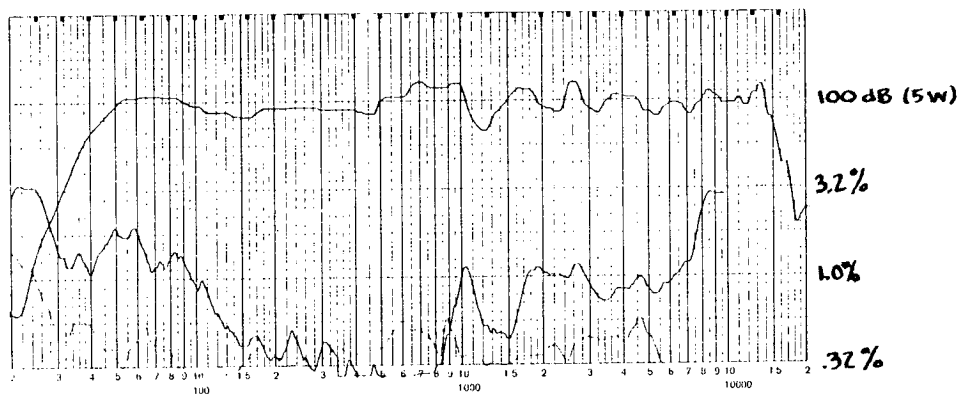
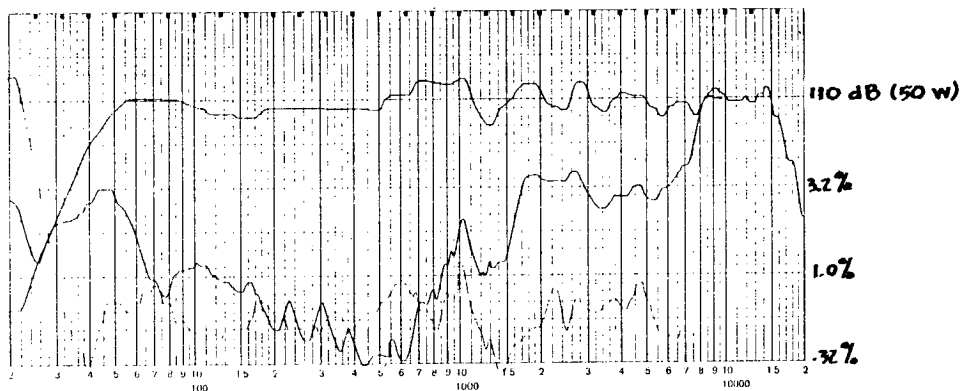

Fig. 17. Power compression at input levels of 1, 10, 100 W: 93, 103, 113 dB at 1 m (4430).



(a)



(b)

Fig. 18. Harmonic distortion versus frequency at two input powers (4430). (a) 5W input. (b) 50W input. Distortion curves raised by 20 dB. Second and third harmonic distortion components measured to 20 000 Hz only.

for the monitors are not always ideal. Further, the user's concept of monitor balance may not agree with that of the manufacturer. Even though we believe that constant coverage monitors will require less equalization than previous designs, the need for equalization may still exist.

One of the more curious aspects of the recording art is the high-frequency tailoring of playback monitors. Amplifiers are flat to one-tenth of a decibel; the ideal microphone is supposedly flat; tape recorders are aligned with great care in order to have as flat a response as possible—yet control-room monitors are traditionally rolled off, typically as much as 3 dB per octave above 4000 Hz (Schulein [10]). If this is not done, the response is often thought to be overly bright. Recent studies have shown that equalizing to such a rolled off curve is merely a roundabout way of arriving at a flat direct sound field by allowing for the effects of increasing directivity and decreasing reverberant field intensity at high frequencies. In effect, we have been equalizing the reverberant field but listening to the direct field (Queen [11], Bridges [12]). When measured in the reverberant field, the typical house curve exhibits a rolled off high end because previous monitors shared a similar power response rolloff. The degree of success with which a monitor could be properly equalized depended

on its direct field being flat when its power response was adjusted to this empirical "house curve" (Fig. 21). Deviations in the power response from this house curve would be equalized to yield complementary response errors in the direct field. For those cases where the power response did not properly follow the direct field response, equalizing would make the direct response worse, and hence degrade the perceived balance. The high degree of parallelism between the axial and the power responses of the new monitor design means that less high-end equalization will be required and, of greater importance, that equalization will always be an improvement and never a degradation.

6.2 Stereo Imaging Will Be Improved

The frequency response of the new monitor design (Fig. 22) is quite uniform, even at angles sufficiently off axis both horizontally and vertically to be unlikely listener positions. However, this results in more uniform room reflections, which contributes to a stable virtual source that does not change with frequency (Queen [13]). In addition, increased toe-in can be used with no degradation of the direct sound field. If enough toe-in is used for the axes of the systems to cross somewhat in front of the listener, then the level precedence effect

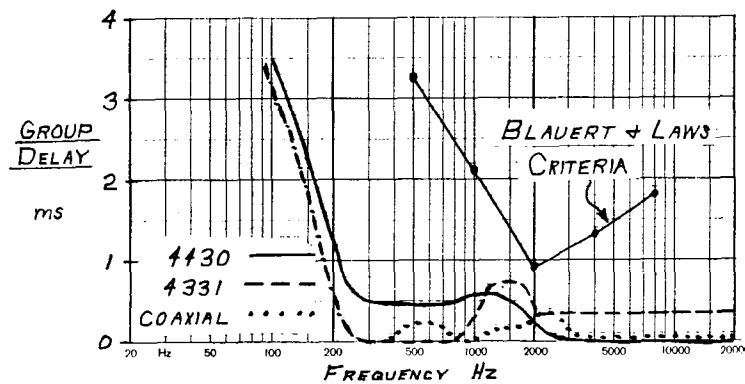

Fig. 19. Group delay versus Blauert and Laws criteria.

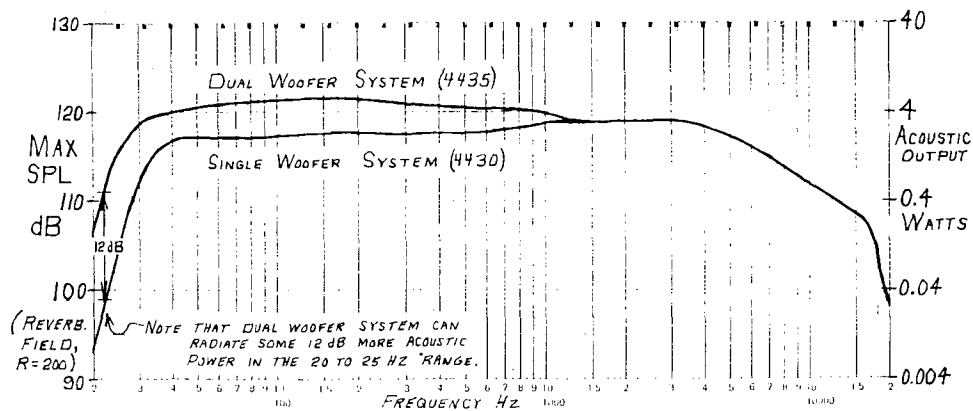

Fig. 20. Maximum continuous output (4430, 4435).

can partially offset the time precedence effect (Haas [14]). This contributes to a more stable stereo image as the listener's position varies along the length of the control board.

7 CONCLUSION

As all other parts of the recording chain are improved, the playback monitors must follow suit. Previous mon-

itors had adequately flat axial frequency response and high acoustic output. By paying attention to power response and off-axis response, a monitor with fewer "colorations" and improved stereo effects can be realized. The use of a constant-coverage horn allows the designer to create a two-way monitor that surpasses three- or even four-way monitors in several of these important aspects.

8 REFERENCES

[1] D. B. Keele, Jr., "What's so Sacred about Exponential Horns?" presented at the 51st Convention of the Audio Engineering Society, *J. Audio Eng. Soc. (Abstracts)*, vol. 23, p. 492 (1975 July/Aug.), preprint 1038.

[2] C. A. Henriksen and M. S. Ureda, "The Manta-Ray Horns," *J. Audio Eng. Soc.*, vol. 26, pp. 629-634 (1978 Sept.).

[3] R. J. Newman, "The Constant Directivity White Horn White Paper," *Electro-Voice, The PA Bible*, no. 6 (1980).

[4] M. R. Gander, "Moving-Coil Loudspeaker Topology as an Indicator of Linear Excursion Capability," *J. Audio Eng. Soc.*, vol. 29, pp. 10-26 (1981 Jan./Feb.).

[5] J. R. Gilliom, "Distortion in Dynamic Loudspeakers Due to Modulation of the Permanent Field," presented at the 42nd Convention of the Audio Engineering Society, *J. Audio Eng. Soc. (Abstracts)*, vol. 20, p. 430 (1972 June).

[6] T. H. Wiik, "Transient Distortion Caused by Nonlinearities in Driving Force and Suspension of a Loudspeaker," presented at the 56th Convention of the Audio Engineering Society, *J. Audio Eng. Soc. (Abstracts)*, vol. 25, p. 336 (1977 May), preprint 1205.

[7] S. H. Linkwitz, "Active Crossover Networks for Noncoincident Drivers," *J. Audio Eng. Soc.*, vol. 24, pp. 2-8 (1976 Jan./Feb.).

[8] D. B. Keele, Jr., "Automated Loudspeaker Polar Response Measurements under Microcomputer Control," presented at the 65th Convention of the Audio Engineering Society, *J. Audio Eng. Soc. (Abstracts)*, vol. 28, p. 374 (1980 May), preprint 1586.

[9] J. Blauert and P. Laws, "Group Delay Distortions in Electroacoustical Systems," *J. Acoust. Soc. Am.*, vol. 63, pp. 1478-1483 (1978 May).

[10] R. B. Schulein, "In Situ Measurement and Equalization of Sound Reproduction Systems," *J. Audio Eng. Soc.*, vol. 23, pp. 178-186 (1975 Apr.).

[11] D. Queen, "Relative Importance of the Direct and Reverberant Fields to Spectrum Perception," *J. Audio Eng. Soc. (Project Notes)*, vol. 21, pp. 119-121 (1973 Mar.).

[12] S. Bridges, "Effect of Direct Sound on the Perceived Frequency Response of a Sound System," presented at the 66th Convention of the Audio Engineering Society, *J. Audio Eng. Soc. (Abstracts)*, vol. 28, p. 552 (1980 July/Aug.), preprint 1644.

[13] D. Queen, "The Effect of Loudspeaker Radiation Patterns on Stereo Imaging and Clarity," *J. Audio Eng. Soc.*, vol. 27, pp. 368-379 (1979 May).

[14] H. Haas, "The Influence of a Single Echo on the Audibility of Speech," *J. Audio Eng. Soc.*, vol. 20, pp. 146-159 (1972 Apr.).

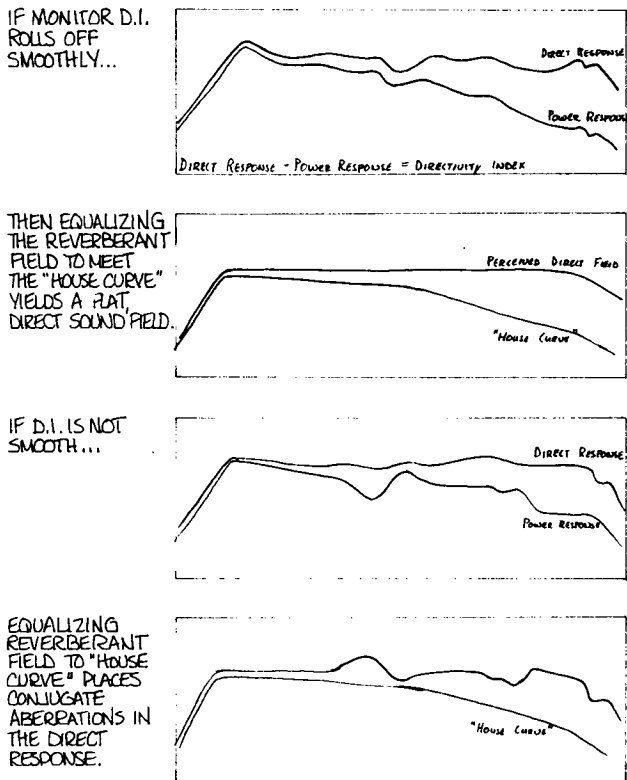

Fig. 21. Reverberant field equalization.

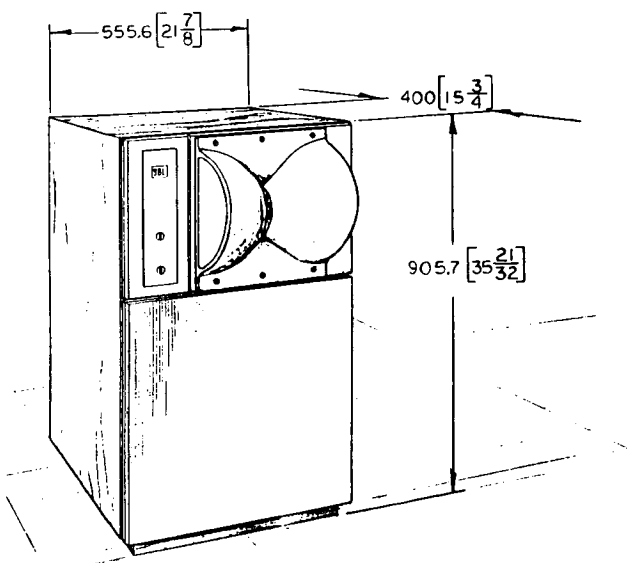

Fig. 22. 4430 monitor.

THE AUTHORS



D. Smith



D. Keele

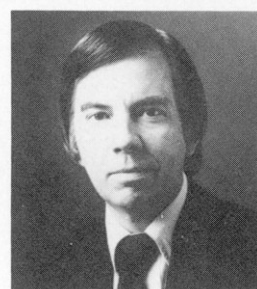

J. Eargle

David Smith received a B.S.E.E. degree from Purdue University in 1977. He began work as a designer of loudspeaker drivers and home loudspeaker systems for Cletron division of Essex (now Harmon-Motive) in Cleveland. In 1980 he moved to California where he worked for JBL. He was responsible for the design of the first four monitors of the 4400 series. Early in 1983 he left JBL, and is now doing acoustical consulting.

D. B. (Don) Keele, Jr., recipient of the AES second Publication Award in 1975, to "an author under 35 years," was born in Los Angeles, California, in 1940. After serving in the U.S. Air Force for four years as an aircraft electronics technician, he attended California State Polytechnic University at Pomona, where he graduated with honors and B.S. degrees in both electrical engineering (majoring in electronics) and physics. Mr. Keele worked three years for Brigham Young University in Provo, Utah, as an audio systems design engineer in the electronic media department. There, too, he received his M.S. degree in electrical engineering in 1975 with a minor in acoustics.

From 1972 to 1976, Mr. Keele was with Electro-Voice, Inc. in Buchanan, Michigan, as a senior design engineer in loudspeakers, concentrating on the design of high-frequency horns and low-frequency direct-radiator vented-box loudspeaker systems. He is the primary designer of their "HR" series of constant directivity high-frequency horns on which he holds the patent. In 1976, Mr. Keele worked for Klipsch and Associates in Hope, Arkansas, as chief engineer involved in the company's commercial line of industrial loudspeakers. In October 1977, he joined James B. Lansing Sound, Inc. in Northridge, California, as a senior transducer engineer, and is currently working on high-frequency horn and transducer design, with

heavy emphasis on computer-aided methods for acoustical design, analysis and testing. He also holds the patent on JBL's "Bi-Radial" series of constant directivity/coverage HF horns which he received early in 1982.

A member and fellow of the Audio Engineering Society, Mr. Keele has presented and published a number of papers on loudspeaker design and measurement methods, among them the paper for which he won the AES Publication Award, "Low-Frequency Loudspeaker Assessment by Nearfield Sound-Pressure Measurement" (*J. Audio Eng. Soc.*, vol. 22, p. 154, 1974 April). Mr. Keele has been an invited speaker at many AES section meetings and loudspeaker conferences.

John Eargle holds degrees in music and electrical engineering from the Eastman School of Music (B.M.), University of Michigan (M.M.), University of Texas (B.S.E.E.), and Cooper Union (M.E.). He is a member of the Acoustical Society of America and Society of Motion Picture and Television Engineers, a senior member of the IEEE, and a fellow and honorary member of the AES. He is a past president of the AES and is active in reviewing papers for the *Journal*.

He worked for RCA Records and Mercury Records in a variety of positions during the sixties. During the early seventies, he worked for the Altec Corporation and formed the consulting firm of JME Associates. Since 1976 he has been associated with JBL Incorporated of Northridge, California, in the areas of product development and product application. Since March 1982, he has expanded his activities in the areas of recording engineering and producing. He is a copious writer, having published more than forty technical articles and record reviews. His books, *Sound Recording* and *The Microphone Handbook*, are widely used as texts at the university level.